

ANGEL CD 6642

DESIGNER COLLECTION

H | S

PVC SYSTEMS INCLUDE:

- 6 Fully directional adjustable PVC jets
- Anti-vortex safety suction
- Color matched system trim
- HydroOzone ozone sanitation system
- Rigid PVC piping
- Self draining pump and system
- Soft Touch electronic on/off control with 30-minute integral times
- 2.25 HP single speed pump
- Cable waste and overflow
- Requires 20 Amp Dedicated GFCI



The Angel, simplicity and function are the key to this design. It is truly represented by its name. Visit <http://www.hydrosystem.com> for more details on our options and accessories.



OPTIONS

- *Grab Bars
- *Integral waste and overflow (linear)
- *Chromatherapy-LED Lighting System
- Chromatherapy-LED Mini Spotlights
- Indulge System
- Microban Antibacterial Protection
- Extra high density fiberglass
- Custom jet and pump locations
- Armrests available
- Skirt
- Plated Metal Finish
- Additional directional Jets
- Swirling, Rotating, or Jumbo Jets
- Micro Therapy Jet
- Integral waste and overflow (circular)
- Masseur Pillow
- 1.5 HP Variable Speed Pump (digital temperature display optional)
- Electronic low water protection
- In-line heater
- Mood Light
- Hydro Fragrance
- Hydro Fusion
- Hydro Coat
- Hydro Express quick ship

HYDRO SYSTEMS
Family Owned And Operated Since 1978

29132 Avenue Paine, Valencia, CA, 91355
661.775.0686 | hydrosystem.com

* Indicates options that are shown (listed in order from top to bottom/ left to right)

ANGEL CD 6642

H|S

DESIGNER COLLECTION

As SHOWN:

Whirlpool option with standard jet location

FEATURES SHOWN:

- Jets
- Overflow location

ALSO AVAILABLE:

- Soaking tub only
- Whirlpool
- Thermal Air
- Combo

SIZE:

66.42.22

WATER CAPACITY:

85 Gallons

WEIGHT:

75 Pounds

MODEL 6642 DIMENSIONS:

- (L)ength- 66"
- (W)idth- 42"
- (H)eight Finish- 22"

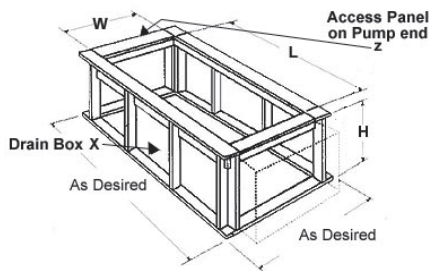

ACRYLIC TUB

- Acrylic models finished in 1/8" thick layer of deep lustrous acrylic
- Extra thick reinforced fiberglass
- Pre-wired pump on pump platform (standard pump location only)
- Integral E-Z level platform facilitates installation

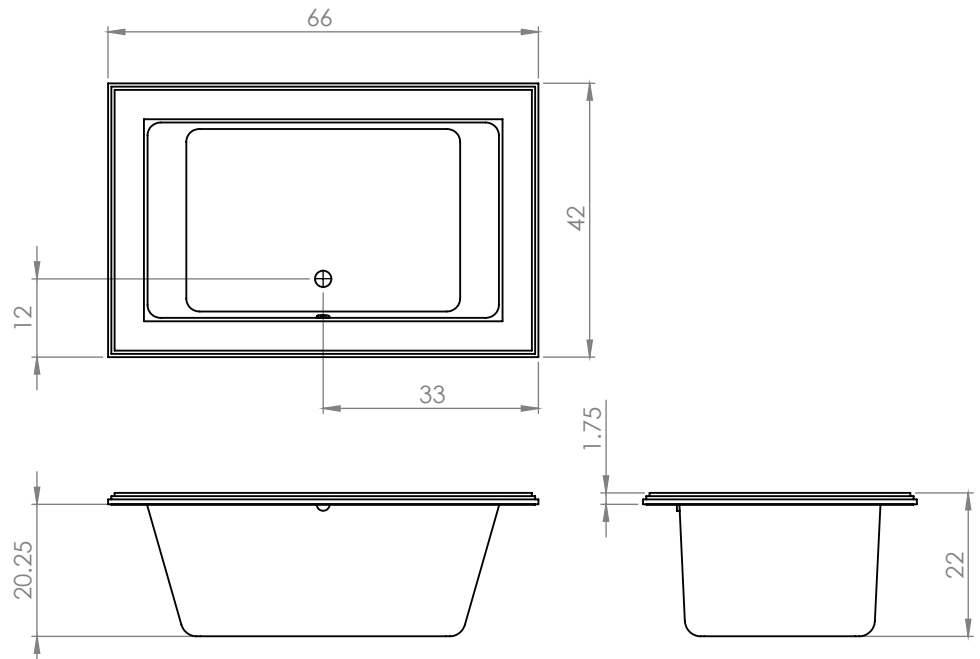

CODES AND COMPLIANCES

Massachusetts code File no: P1-0614-491



HYDRO SYSTEMS
Family Owned And Operated Since 1978

29132 Avenue Paine. Valencia, CA, 91355
661.775.0686 | hydrosystem.com

All specifications and options subject to change without notice please contact a Hydro Systems representative for more information. Certain options or altering the pump/blower location may cause the pump/blower to extend beyond the tub decking. For cutout dimensions wait for unit to arrive. All specifications subject to change without notice.